



# XCubeDAS CubeView User's Manual

Applicable Models:

XD5324D, XD5324S, XD5316D, XD5316S

XD5312D, XD5312S, XD5326D, XD5326S



QSAN Technology, Inc.

[www.QSAN.com](http://www.QSAN.com)



## **Copyright**

© Copyright 2020 QSAN Technology, Inc. All rights reserved. No part of this document may be reproduced or transmitted without written permission from QSAN Technology, Inc.

## **December 2020**

This edition applies to QSAN XCubeDAS CubeView central management software. QSAN believes the information in this publication is accurate as of its publication date. The information is subject to change without notice.

## **Trademarks**

QSAN, the QSAN logo, CubeView, XCubeDAS, and QSAN.com are trademarks or registered trademarks of QSAN Technology, Inc.

Microsoft, Windows, Windows Server, and Hyper-V are trademarks or registered trademarks of Microsoft Corporation in the United States and/or other countries.

Other trademarks and trade names used in this document to refer to either the entities claiming the marks and names or their products are the property of their respective owners.

## Notices

---

This XCubeDAS hardware owner's manual is applicable to the following XCubeDAS models:

### **XCubeDAS Storage System 4U 19" Rack Mount Models**

| Model Name | Controller Type   | Form Factor, Bay Count, and Rack Unit |
|------------|-------------------|---------------------------------------|
| XD5324D    | Dual Controller   | LFF 24-disk 4U Chassis                |
| XD5324S    | Single Controller | LFF 24-disk 4U Chassis                |

### **XCubeDAS Storage System 3U 19" Rack Mount Models**

| Model Name | Controller Type   | Form Factor, Bay Count, and Rack Unit |
|------------|-------------------|---------------------------------------|
| XD5316D    | Dual Controller   | LFF 16-disk 3U Chassis                |
| XD5316S    | Single Controller | LFF 16-disk 3U Chassis                |

### **XCubeDAS Storage System 2U 19" Rack Mount Models**

| Model Name | Controller Type   | Form Factor, Bay Count, and Rack Unit |
|------------|-------------------|---------------------------------------|
| XD5312D    | Dual Controller   | LFF 12-disk 2U Chassis                |
| XD5312S    | Single Controller | LFF 12-disk 2U Chassis                |
| XD5326D    | Dual Controller   | SFF 26-disk 2U Chassis                |
| XD5326S    | Single Controller | SFF 26-disk 2U Chassis                |

Information contained in this manual has been reviewed for accuracy. But it could include typographical errors or technical inaccuracies. Changes are made to the document periodically. These changes will be incorporated in new editions of the publication. QSAN may make improvements or changes in the products. All features, functionality, and product specifications are subject to change without prior notice or obligation. All statements, information, and recommendations in this document do not constitute a warranty of any kind, express or implied.

Any performance data contained herein was determined in a controlled environment. Therefore, the results obtained in other operating environments may vary significantly. Some measurements may have been made on development-level systems and there is no guarantee that these measurements will be the same on generally available systems.

Furthermore, some measurements may have been estimated through extrapolation. Actual results may vary. Users of this document should verify the applicable data for their specific environment.

This information contains examples of data and reports used in daily business operations. To illustrate them as completely as possible, the examples include the names of individuals, companies, brands, and products.

All of these names are fictitious and any similarity to the names and addresses used by an actual business enterprise is entirely coincidental.

# Table of Contents

---

|   |            |
|---|------------|
| <b>Notices</b> .....                        | <b>i</b>   |
| <b>Preface</b> .....                        | <b>vii</b> |
| About This Manual .....                     | vii        |
| Related Documents .....                     | vii        |
| Technical Support .....                     | vii        |
| Information, Tip, and Caution .....         | viii       |
| Conventions .....                           | viii       |
| <b>1. Overview</b> .....                    | <b>1</b>   |
| 1.1. Introduction to CubeView .....         | 1          |
| 1.2. Languages Support.....                 | 3          |
| <b>2. Getting Started</b> .....             | <b>4</b>   |
| 2.1. Download CubeView Software.....        | 4          |
| 2.2. Starting CubeView .....                | 4          |
| 2.2.1. Device Finder .....                  | 6          |
| 2.2.2. Device List .....                    | 6          |
| 2.2.3. Event Log .....                      | 8          |
| 2.2.4. Dashboard .....                      | 10         |
| 2.2.5. Agent Mode .....                     | 10         |
| 2.2.6. About CubeView.....                  | 12         |
| <b>3. Management and Monitoring</b> .....   | <b>14</b>  |
| 3.1. System Information .....               | 14         |
| 3.1.1. Firmware Upgrade.....                | 15         |
| 3.2. SAS Zoning .....                       | 16         |
| 3.2.1. SAS Zoning Cabling .....             | 24         |
| 3.3. Device Slot.....                       | 25         |
| 3.4. Power Supply.....                      | 26         |
| 3.5. Cooling Device .....                   | 27         |
| 3.6. Temperature Sensor .....               | 28         |
| 3.7. Voltage Sensor .....                   | 30         |
| 3.8. SAS Expander.....                      | 31         |
| 3.9. SAS Port.....                          | 32         |
| <b>4. Support and Other Resources</b> ..... | <b>33</b>  |
| 4.1. Getting Technical Support.....         | 33         |
| 4.2. Accessing Product Updates.....         | 33         |



4.3. Documentation Feedback ..... 34

**Appendix..... 35**

End-User License Agreement (EULA) ..... 35

# Figures

---

|             |  |    |
|-------------|--|----|
| Figure 1-1  | CubeView System Architecture Diagram.....                              | 1  |
| Figure 2-1  | CubeView Icon.....   | 4  |
| Figure 2-2  | CubeView Desktop Panel.....  | 5  |
| Figure 2-3  | Device Finder .....  | 6  |
| Figure 2-4  | Edit the Device List.....  | 6  |
| Figure 2-5  | System Information.....  | 7  |
| Figure 2-6  | Management and Monitoring .....  | 8  |
| Figure 2-7  | Event Log of Firmware Upgrade.....                                     | 9  |
| Figure 2-8  | Event Log of Error on Power Supply and Fan .....                       | 9  |
| Figure 2-9  | Dashboard Information .....  | 10 |
| Figure 2-10 | Agent Mode Confirmation .....  | 11 |
| Figure 2-11 | CubeView Agent Icon on Taskbar .....                                   | 11 |
| Figure 2-12 | CubeView Agent to Add Authorized Clients .....                         | 11 |
| Figure 2-13 | Authorized Client Assignment.....                                      | 12 |
| Figure 2-14 | About CubeView .....   | 13 |
| Figure 3-1  | System Information.....  | 14 |
| Figure 3-2  | Firmware Upgrade File Selection .....                                  | 15 |
| Figure 3-3  | SAS Zoning Configuration .....   | 17 |
| Figure 3-4  | All SAS Ports Access All Disk Drives Diagram .....                     | 18 |
| Figure 3-5  | All SAS Ports Access All Drives Configuration.....                     | 19 |
| Figure 3-6  | SAS Ports and Disk Drives Divided into Two Groups Diagram .....        | 20 |
| Figure 3-7  | SAS Ports and Disk Drives Divided into Two Groups Configuration.....   | 21 |
| Figure 3-8  | SAS Ports and Disk Drives Divided into Five Groups Diagram.....        | 22 |
| Figure 3-9  | SAS Ports and Disk Drives Divided into Five Groups Configuration ..... | 23 |
| Figure 3-10 | Two Servers to One XCubeDAS / Two Zones .....                          | 24 |
| Figure 3-11 | Two Servers to Three XCubeDAS / Two SAS Zones.....                     | 25 |
| Figure 3-12 | Device Slots Status.....   | 26 |
| Figure 3-13 | Power Supply Status Indicators .....                                   | 27 |
| Figure 3-14 | Cooling Device Status Indicators .....                                 | 28 |
| Figure 3-15 | Temperature Sensor Status Indicators.....                              | 29 |
| Figure 3-16 | Voltage Sensor Status Indicators.....                                  | 31 |
| Figure 3-17 | SAS Expander Information.....  | 32 |
| Figure 3-18 | SAS Port Connectivity Status .....                                     | 32 |

# Tables

---

Table 1-1    Operation System Compatibility..... 2  
Table 2-1    CubeView Panel Layout ..... 5



# Preface

---

## About This Manual

This manual provides technical guidance for designing and implementing QSAN XCubeDAS series DAS system, and it is intended for use by system administrators, DAS designers, storage consultants, or anyone who has purchased these products and is familiar with servers and computer networks, network administration, storage system installation and configuration, storage area network management, and relevant protocols.



---

**CAUTION:**

Do NOT attempt to service, change, disassemble or upgrade the equipment's components by yourself. Doing so may violate your warranty and expose you to electric shock. Refer all servicing to authorized service personnel. Please always follow the instructions in this owner's manual.

---

## Related Documents

There are related documents which can be downloaded from the website.

- [All XCubeDAS Documents](#)
- [XCubeDAS OIG \(Quick Installation Guide\)](#)
- [XCubeDAS Hardware Owner's Manual](#)
- [XCubeDAS CubeView User's Manual](#)
- [XCubeDAS CLI User's Manual](#)
- [Compatibility Matrix](#)
- [White Papers](#)
- [Application Notes](#)

## Technical Support

Do you have any questions or need help trouble-shooting a problem? Please contact QSAN Support, we will reply to you as soon as possible.

- Via the Web: <https://qsan.com/support>
- Via Telephone: +886-2-7720-2118 extension 136  
(Service hours: 09:30 - 18:00, Monday - Friday, UTC+8)
- Via Skype Chat, Skype ID: qsan.support  
(Service hours: 09:30 - 02:00, Monday - Friday, UTC+8, Summer time: 09:30 - 01:00)
- Via Email: [support@qsan.com](mailto:support@qsan.com)

## Information, Tip, and Caution

This manual uses the following symbols to draw attention to important safety and operational information.



**INFORMATION:**

INFORMATION provides useful knowledge, definition, or terminology for reference.

---



**TIP:**

TIP provides helpful suggestions for performing tasks more effectively.

---



**CAUTION:**

CAUTION indicates that failure to take a specified action could result in damage to the system.

---

## Conventions

The following table describes the typographic conventions used in this manual.

| Conventions | Description  |
|-------------|--|
| <b>Bold</b> | Indicates text on a window, other than the window title, including menus, menu options, buttons, fields, and labels.<br>Example: Click the <b>OK</b> button. |

|                     |  |
|---------------------|--|
| < <i>Italic</i> >   | Indicates a variable, which is a placeholder for actual text provided by the user or system.<br>Example: copy <source-file> <target-file>. |
| [ ] square brackets | Indicates optional values.<br>Example: [ a   b ] indicates that you can choose a, b, or nothing.   |
| { } braces          | Indicates required or expected values.<br>Example: { a   b } indicates that you must choose either a or b.                                 |
| vertical bar        | Indicates that you have a choice between two or more options or arguments.   |
| / Slash             | Indicates all options or arguments.  |
| underline           | Indicates the default value.<br>Example: [ <u>a</u>   b ]  |



# 1. Overview

Thank you for purchasing QSAN Technology, Inc. products. QSAN CubeView CMS (Central Management Software) is designed for users who purchases XCubeDAS system as space expansion devices without QSAN XCubeSAN as the head unit. It provides basic XCubeDAS system setting and status monitoring. In CubeView, users can monitor and manage system log, disk drive status, enclosure, zoning function, firmware update, and history record of system temperature, voltage, and fan speed. And designate certain disk drives for a dedicated SAS port for security (SAS zoning). Users can also turn on the UID (Unique Identifier) LED of system or the status LED to identify disk drives. The CubeView CMS is an easy management utility for XCubeDAS system users.

## 1.1. Introduction to CubeView

The CubeView CMS is composed of CubeView client and CubeView agent(s). The following diagram shows the CubeView system architecture.

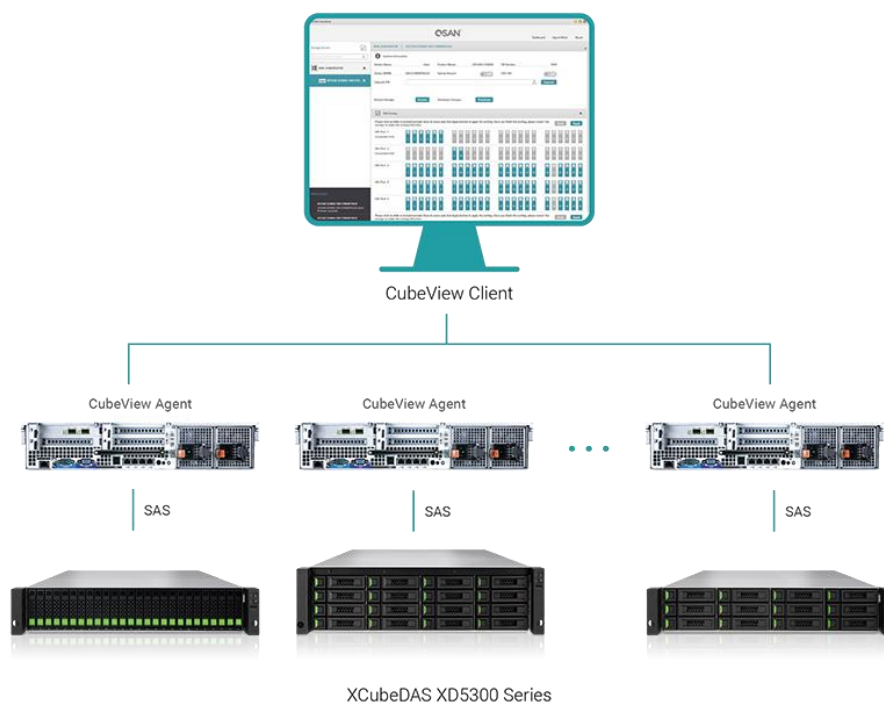

Figure 1-1 CubeView System Architecture Diagram

## CubeView Client

In general case, one management computer installs the CubeView client software which will periodically check the status of the XCubeDAS series systems attached to the servers via the CubeView agents. The CubeView client software plays the role of central management to monitor and manage the XCubeDAS series systems.

## CubeView Agent

The CubeView agent software is installed in the servers which are connected to the XCubeDAS series systems. The CubeView agent software plays the agent role. It receives the SES command from the CubeView client and communicates with the XCubeDAS series systems via SES protocol, and then replies to the CubeView client.



### CAUTION:

The SAS HBAs or SAS RAID cards must support SES protocol. Otherwise, the CubeView will not work properly.



### INFORMATION:

The CubeView software is running in the client mode by default. Please refer to the chapter 2.2.5 [Agent Mode](#) section in the chapter Getting Started for the details of agent mode setting.

Most of the Windows operation systems are supported by the CubeView CMS as below table.

*Table 1-1 Operation System Compatibility*

| Mode                  | Operation System                       |
|-----------------------|--|
| CubeView Client/Agent | Microsoft Windows Server 2008 R2 (x64) |
|                       | Microsoft Windows Server 2012 R2 (x64) |
|                       | Microsoft Windows 7                    |
|                       | Microsoft Windows 8                    |
|                       | Microsoft Windows 10                   |

## 1.2. Languages Support

Here are the CubeView supported languages, it is auto switched by the language setting of operation system.

- English
- French
- German
- Italian
- Japanese
- Korean
- Russian
- Traditional Chinese
- Simplified Chinese

## 2. Getting Started

---

This chapter provides a description of where to download the CubeView software and how to start using CubeView to manage the QSAN XCubeDAS systems.

### 2.1. Download CubeView Software

The latest CubeView software can be downloaded at the website.

<https://qsan.com/CubeView>

After downloading the CubeView software, unzip the file, there are two files included.

- **CubeView.exe**: CubeView main file includes CubeView client and CubeView agent, Windows version.
- **LZMA.dll**: It is Windows dynamic-link libraries, please put it at the same directory as the CubeView.exe file.

The CubeView software can be run directly without installation. Please browse to the location of the CubeView.exe file. You will see the icon as below.

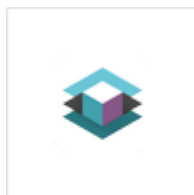

CubeView.exe

Figure 2-1 CubeView Icon



**TIP:**

CubeView.exe itself includes CubeView client and CubeView agent. It can be run as client and agent at the same time in the server.

---

### 2.2. Starting CubeView

Double click the icon to run the CubeView, and you will see the starting page.



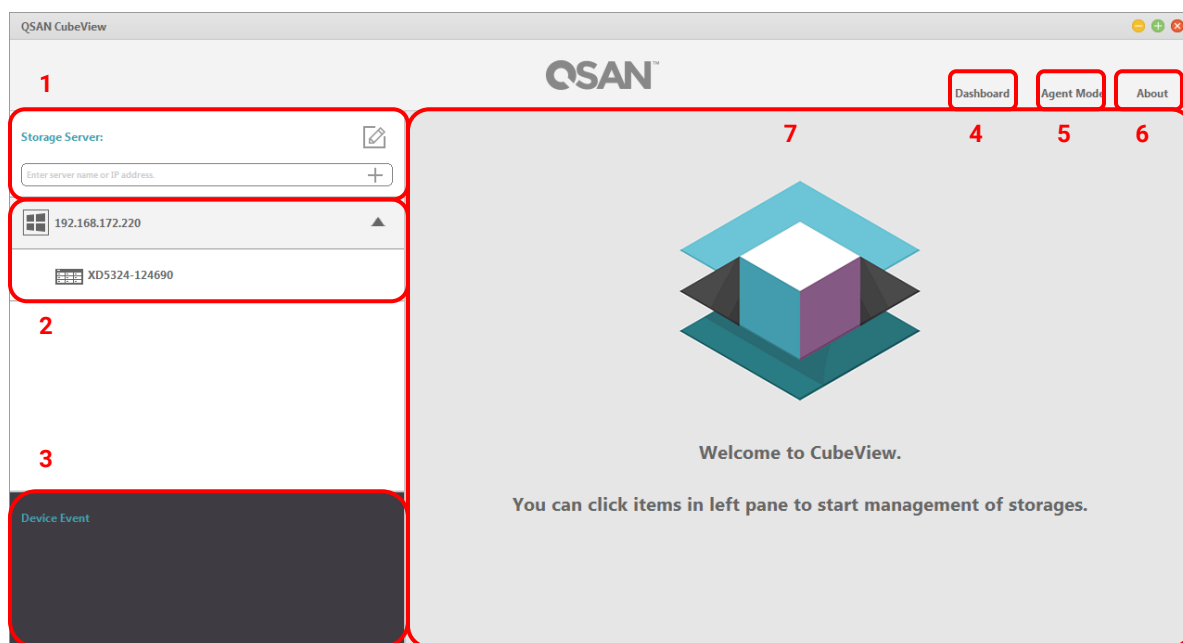

Figure 2-2 CubeView Desktop Panel

Table 2-1 CubeView Panel Layout

| Number | Description   | Details                       |
|--------|---|-------------------------------|
| 1      | <b>Device Finder</b><br>Enter the name or IP address to search your XCubeDAS systems. | Section <a href="#">2.2.1</a> |
| 2      | <b>Device List</b><br>Show all XCubeDAS systems that accessible by CubeView.          | Section <a href="#">2.2.2</a> |
| 3      | <b>Event Log</b><br>Display the latest events of the selected XCubeDAS system.        | Section <a href="#">2.2.3</a> |
| 4      | <b>Dashboard</b><br>Click to show the status summary of the selected XCubeDAS system. | Section <a href="#">2.2.4</a> |
| 5      | <b>Agent Mode</b><br>Click to change the CubeView from client to agent mode.          | Section <a href="#">2.2.5</a> |
| 6      | <b>About CubeView</b><br>Click to show the current CubeView version.                  | Section <a href="#">2.2.6</a> |
| 7      | <b>Main Working Area</b><br>Here user can manage and monitor the XCubeDAS system.     | N/A                           |

The details of the CubeView starting page are described on the following sections.

## 2.2.1. Device Finder

In device finder, enter the server name or IP address which is installed CubeView agent. And then click + to add it into the device list.



Figure 2-3 Device Finder

## 2.2.2. Device List



All QSAN XCubeDAS systems that connect to the CubeView will be shown in the device list. Users can click the device on the list for detail information or start to manage the system. Clicking the  icon can edit / delete the device from the list. Click the  icon again to exit the edit mode.



Figure 2-4 Edit the Device List

Click one of the devices in the list, and then the main working area will show the system information. System information includes the following items.

- System Name
- Vendor Name
- Product Name
- Firmware Version
- Device WWN (World Wide Name)
- System Buzzer
- UID (Unique Identifier) LED
- Upgrade Firmware
- Restart the system
- Shutdown the system

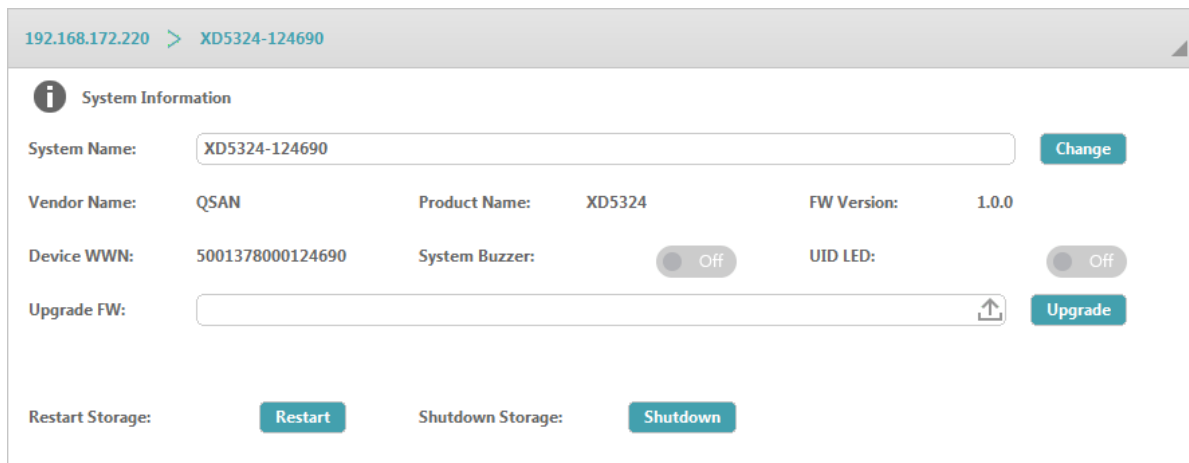

Figure 2-5 System Information

Managing and monitoring is under the system information in the main working area.

- SAS Zoning
- Device Slot
- Power Supply Unit Status Indicator
- Cooling devices
- Temperature sensors
- Voltage sensor
- SAS Expander
- SAS Port

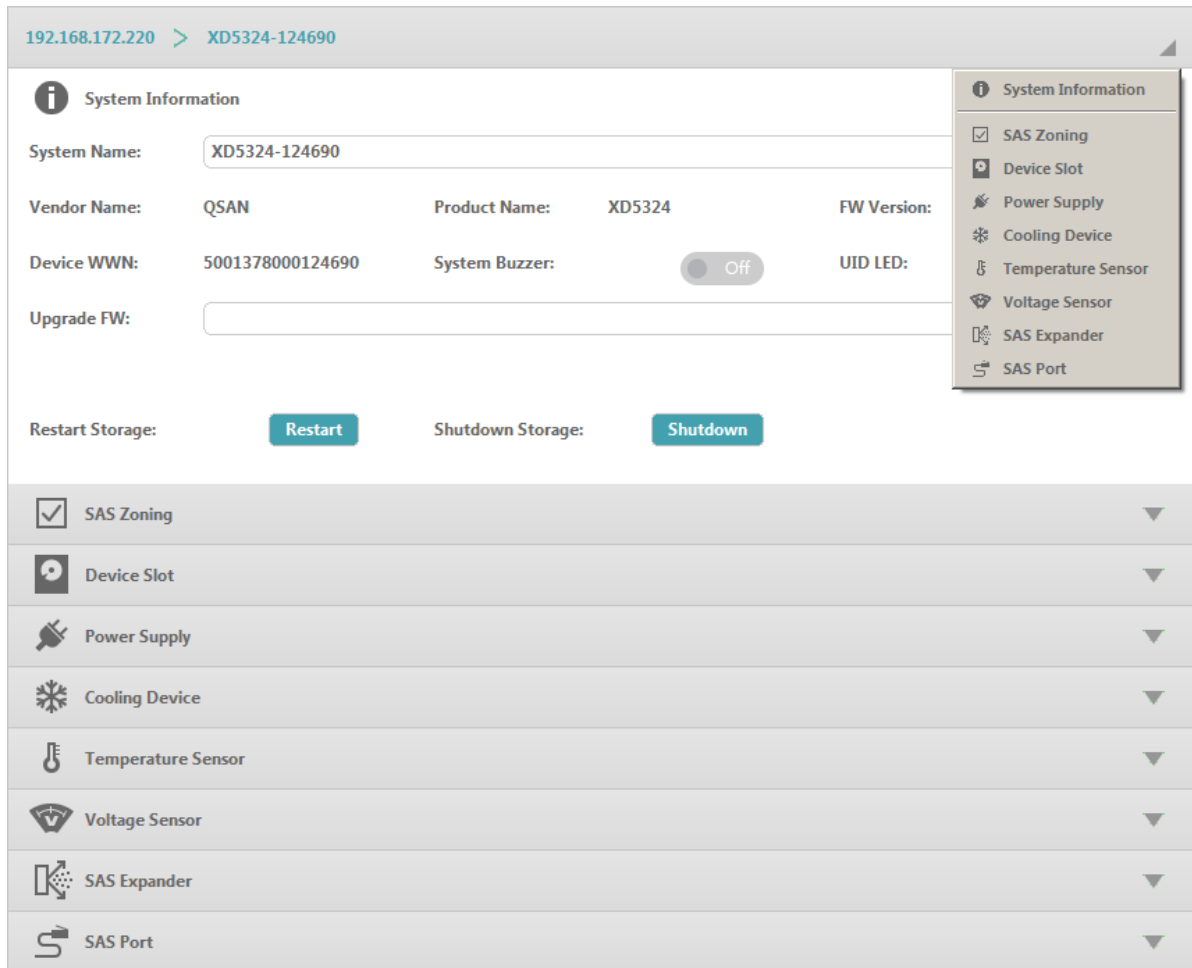



Figure 2-6 Management and Monitoring

In the drop down menu, you can click the item to jump to the options. Or click the  icon to expand the option area. For more information about the operations, please refer to the chapter 3, [Management and Monitoring](#).

### 2.2.3. Event Log

Event log of the CubeView will show the latest events of the XCubeDAS systems that connect to the CubeView. The event log will record important events and critical error status of the system.

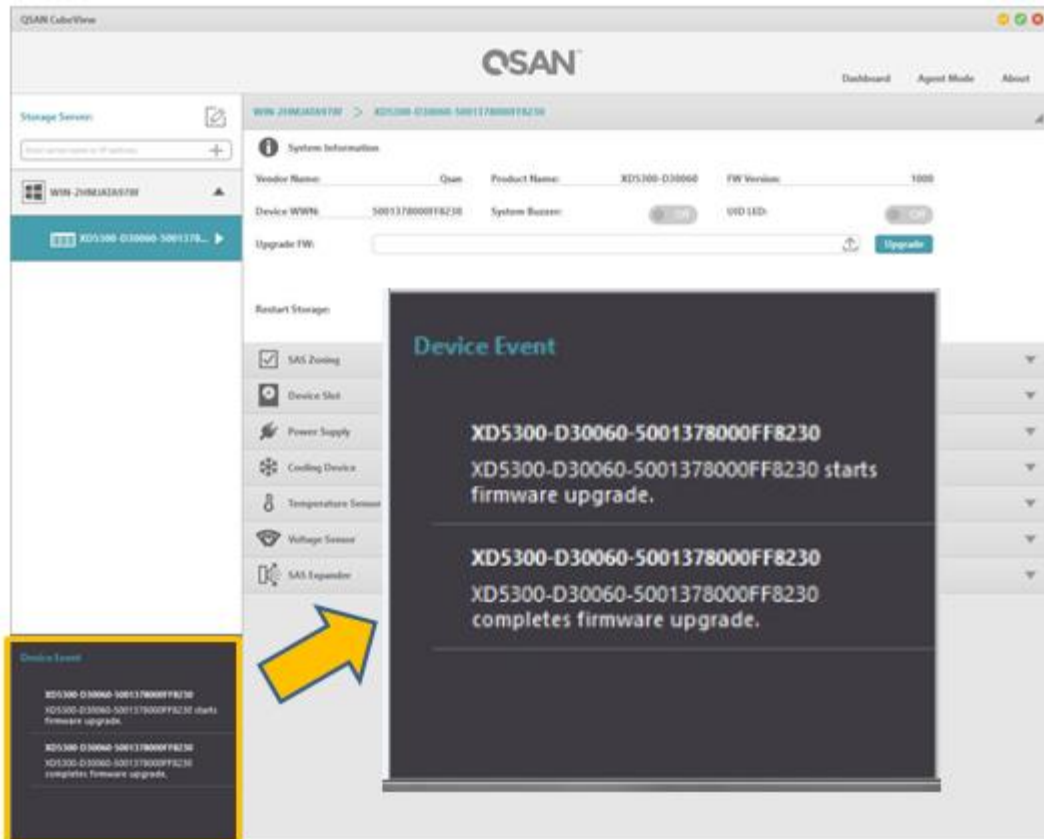

Figure 2-7 Event Log of Firmware Upgrade

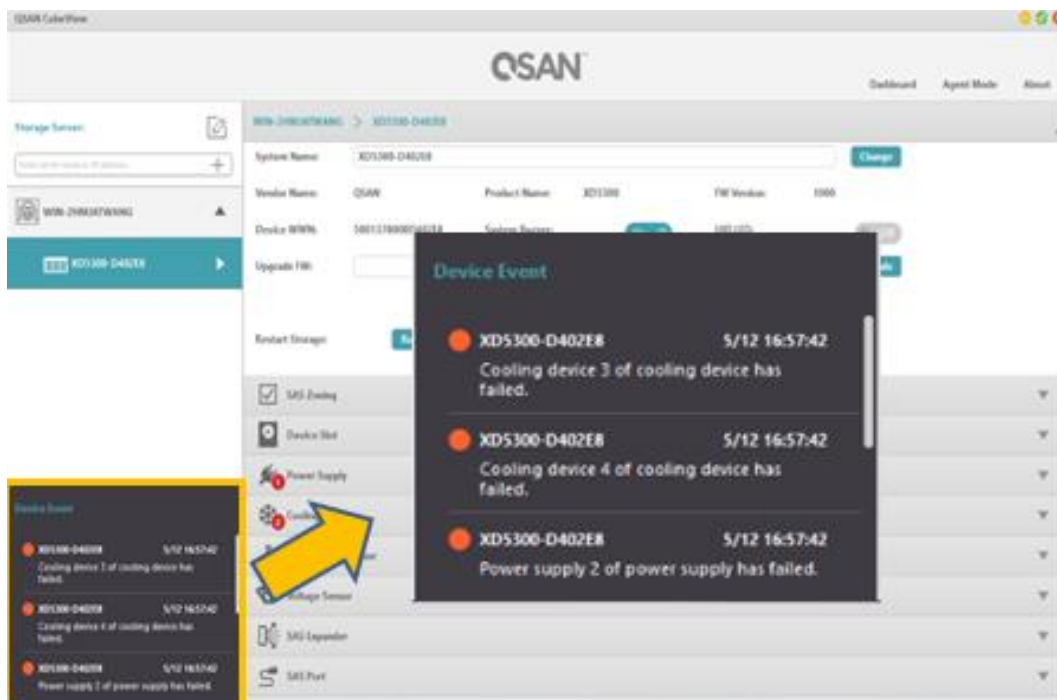
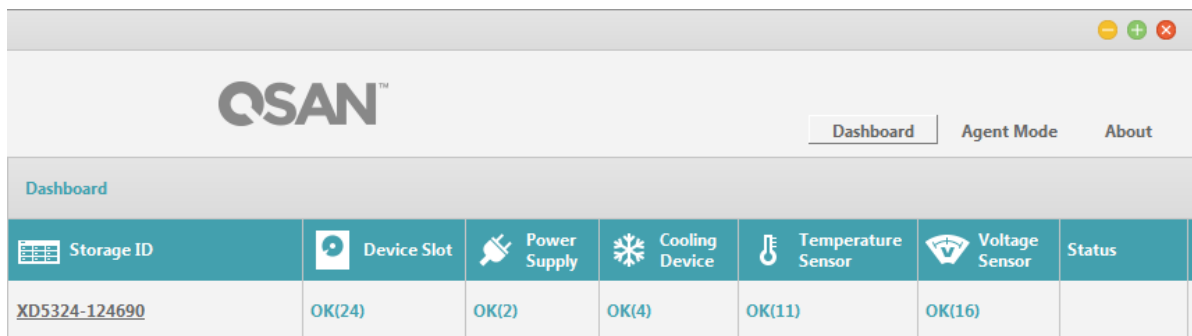

Figure 2-8 Event Log of Error on Power Supply and Fan

## 2.2.4. Dashboard

When users click the **Dashboard** button on the top right corner, the main working area will show the status summary of all managed devices. Dashboard information includes the following items.

- Storage ID
- Device Slots
- Power Supply
- Cooling Device
- Temperature Sensor
- Voltage Sensor
- Status



The screenshot shows a web application window titled 'QSAN' with a navigation bar containing 'Dashboard', 'Agent Mode', and 'About'. The main content area is titled 'Dashboard' and contains a table with the following data:

| Storage ID                    | Device Slot | Power Supply | Cooling Device | Temperature Sensor | Voltage Sensor | Status |
|-------------------------------|-------------|--------------|----------------|--------------------|----------------|--------|
| <a href="#">XD5324-124690</a> | OK(24)      | OK(2)        | OK(4)          | OK(11)             | OK(16)         |        |

Figure 2-9 Dashboard Information

The status shows OK if the items are fine. If the items have problem, it will show fault indicator **Fault**. The numbers in brackets are the total quantity of the items.

## 2.2.5. Agent Mode

When users click the **Agent Mode** button on the top right corner, the CubeView can switch to the agent mode.

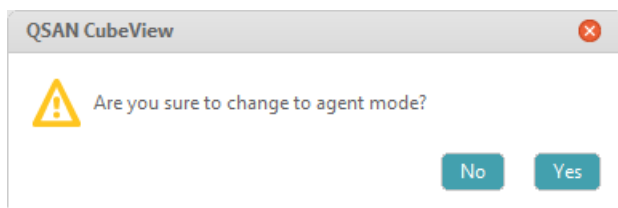

Figure 2-10 Agent Mode Confirmation

Clicking the **Yes** button will confirm switching to the agent mode. The CubeView program will shrink to the Window taskbar.

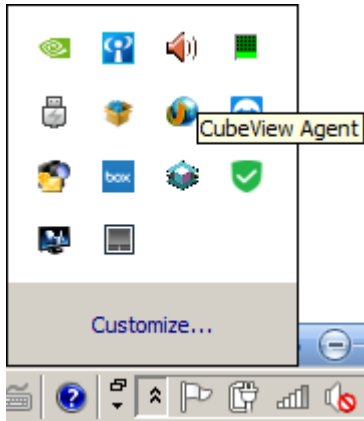

Figure 2-11 CubeView Agent Icon on Taskbar

Click the CubeView Agent icon will pop up a window to add authorized clients.

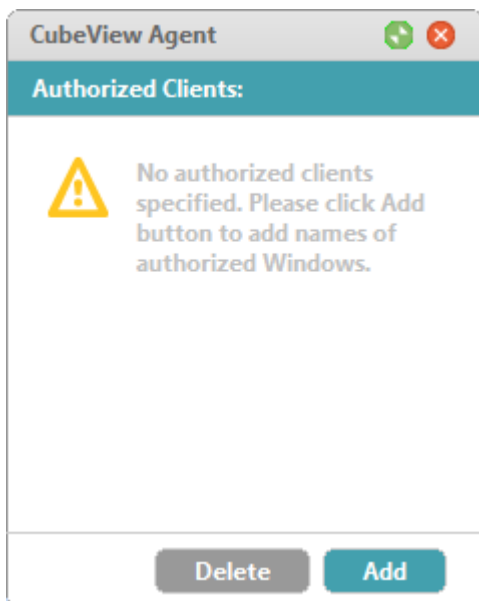

Figure 2-12 CubeView Agent to Add Authorized Clients

Click the Add button to enter the computer name or IP address of the authorized client. In the agent mode, the authorized client should be assigned for the CubeView client to inquire the status.

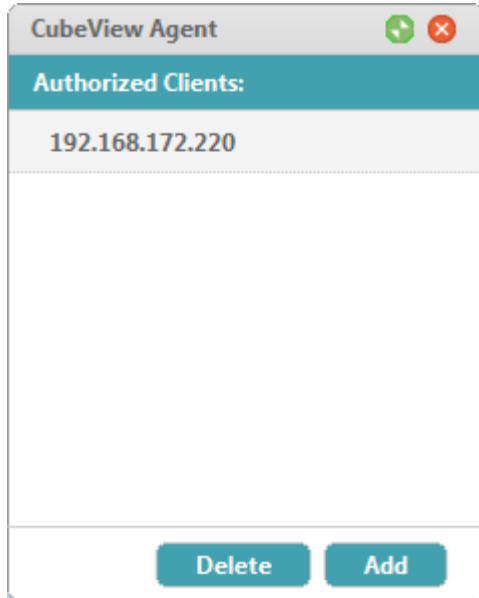

Figure 2-13 Authorized Client Assignment



**INFORMATION:**

For more information about the CubeView client mode and agent mode, please refer to the chapter 1.1 [Introduction to CubeView](#) section in the chapter Overview. The CubeView software is running in the client mode by default.

## 2.2.6. About CubeView

Click the **About** button on the top right corner will pop up a window and show the software version.





*Figure 2-14 About CubeView*

## 3. Management and Monitoring

This chapter will instruct user how to manage and monitor the XCubeDAS system. Before starting, at least one QSAN XCubeDAS system must connect to the CubeView.

### 3.1. System Information

After clicking one of the devices in the CubeView left pane, main working area will show the system information and major monitoring and managing tabs.

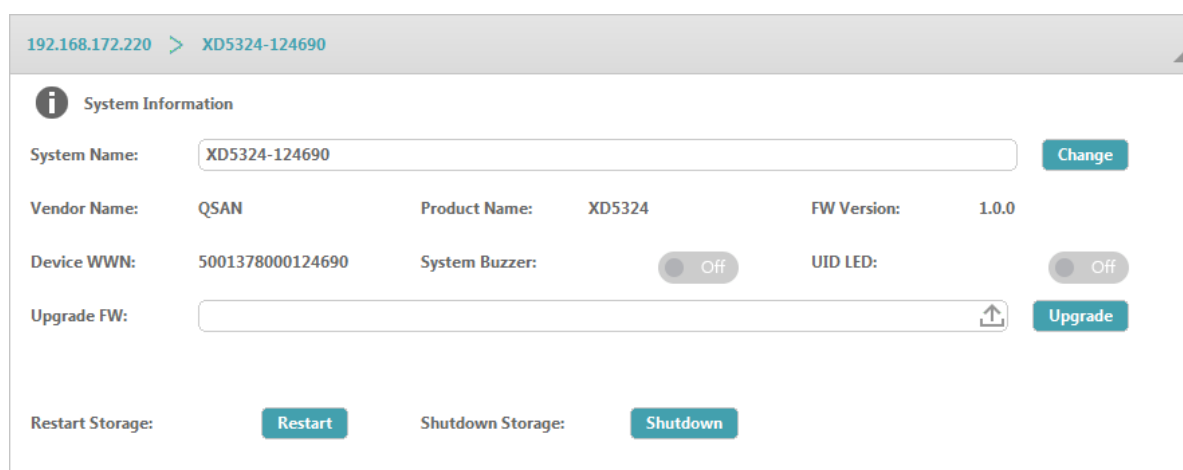

Figure 3-1 System Information

#### Options of System Information

The options available in this tab:

- **System Name:** Change the system name, highlight the old name and type in a new one, and then click the **Change** button. Maximum length of the system name is 32 characters. Valid characters are [ A~Z | a~z | 0~9 | -\_ ].
- **Vendor Name:** The vendor name of the device.
- **Product Name:** The model name of the device.
- **FW Version:** The firmware version of the device.
- **Device WWN:** The WWN (World Wide Name) of the device.
- **System Buzzer:** Click the button to turn off the buzzer.
- **UID LED:** Click the button to turn on or off the UID (Unique Identifier) LED.



**INFORMATION:**

For the front and rear view about the UID LEDs, please refer to chapter 2, System Components Overview in the [XCubeDAS Hardware Owner's Manual](#).

- **Upgrade FW:**
- **Restart Storage:** Click the **Restart** button to reboot the system.



**TIP:**

In dual controller model, restart the system will reboot the controller 1 first, and then controller 2 after 30 seconds.

- **Shutdown Storage:** Click the **Shutdown** button to shutdown the system.

### 3.1.1. Firmware Upgrade

The basic information in the CubeView shows current firmware version and supports firmware update as well. Please prepare new controller firmware file named “xxxx.lzma” in local hard drive. Click the  icon to browse and select the firmware file to upgrade. Please be noted that you must select the \*.lzma file for upgrade.



Figure 3-2 Firmware Upgrade File Selection

When the firmware file selection is done, click the **Upgrade** button to update firmware. And then click the **Yes** button to start the firmware upgrade process. The process bar will indicate the percentage of process, it will take around 4~5 minutes to complete.



**CAUTION:**

After the firmware update completes, the CubeView will automatically reboot the XCubeDAS system to take effect.

---



**INFORMATION:**

To download the product firmware, please visit QSAN website:

<https://qsan.com/download>

---

## 3.2. SAS Zoning

QSAN XCubeDAS XD5300 series system is equipped with 5 SAS ports for each controller that means one XD5300 system can serve five servers as expansion storage in each controller. The XCubeDAS XD5300 series provides SAS zoning features and list the advantage on the following.

1. Easy disk drive management: Users can designate certain disk drive to be accessed by single SAS port. For example, users can designate disk drive slot 1, 2, 3, 4, and 5 for the SAS port 1; the server can only detect and access disk drive slot 1 ~ 5 via the SAS port 1.
2. Data access control: Due to SAS zoning feature can segregate and isolate disk drives from different SAS ports, one SAS port can only detect and access the designated disk drives by users' setting. It provides higher security for IT administrator.

It is strongly recommended to configure SAS zoning after the first installation and initialization of the XCubeDAS system.

Following is the procedures for SAS configuring SAS zoning. We will take the XD5324 (4U 24-bay model) as an example.

1. Make sure the XCubeDAS system power cords are connected to power outlet, all available disk drives are installed into disk drive slots, and then power on the XCubeDAS system.
2. Make sure all servers that connect to SAS ports can detect and access the XCubeDAS system.

3. Click the **SAS Zoning** tab to view all available SAS ports and disk drives.
4. Check or uncheck the disk drive slots to join in the SAS port. The disk drive slots are all checked by default.
5. Click the **Apply** button to apply the SAS zoning settings.

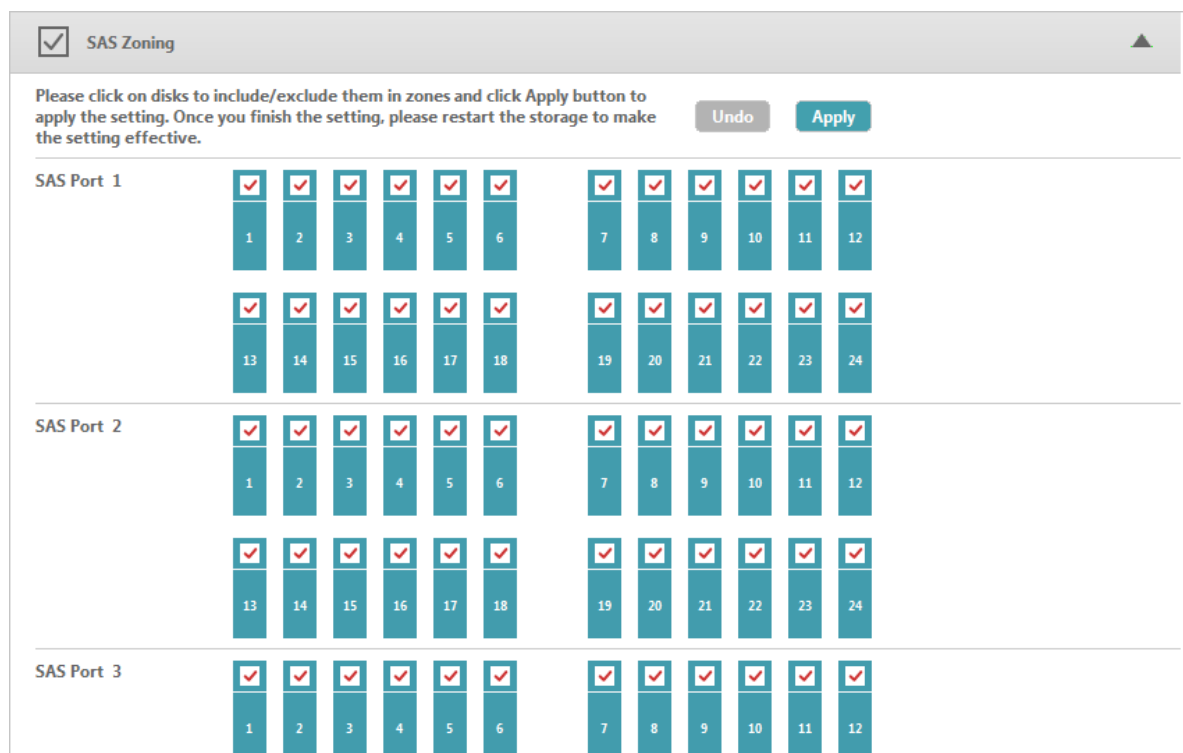

Figure 3-3 SAS Zoning Configuration



**TIP:**

Please note that after applying new SAS zoning configuration, you must reboot the XCubeDAS system to make new zoning configurations take effect.

After restart the XCubeDAS system, server that connected to the SAS port can only detect and access designated the disk drives according to new SAS zoning configuration. We take some SAS zoning examples for your reference.

**All SAS Ports Access All Disk Drives**

The default zoning setting is that all ports can access all drives in the XCubeDAS system.

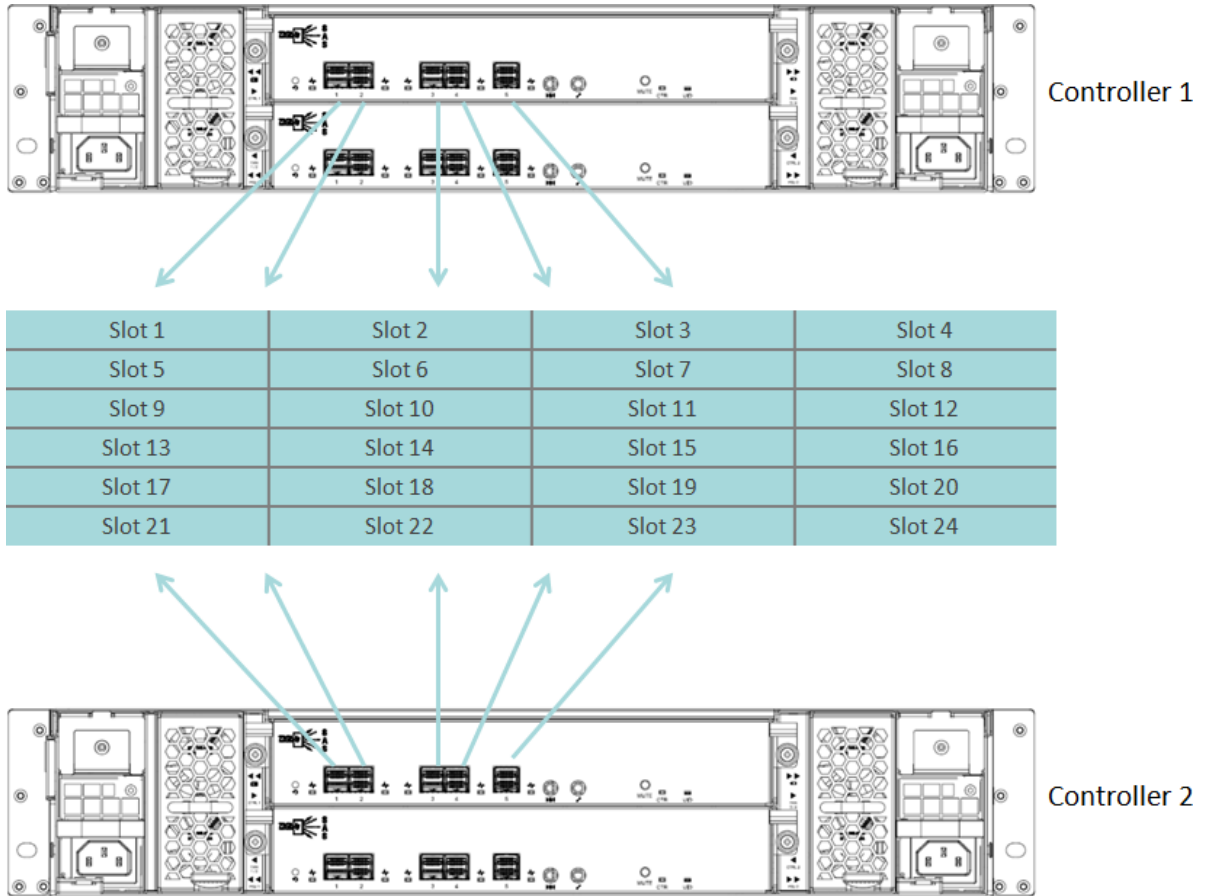

Figure 3-4 All SAS Ports Access All Disk Drives Diagram

The SAS zoning configuration is on the following.

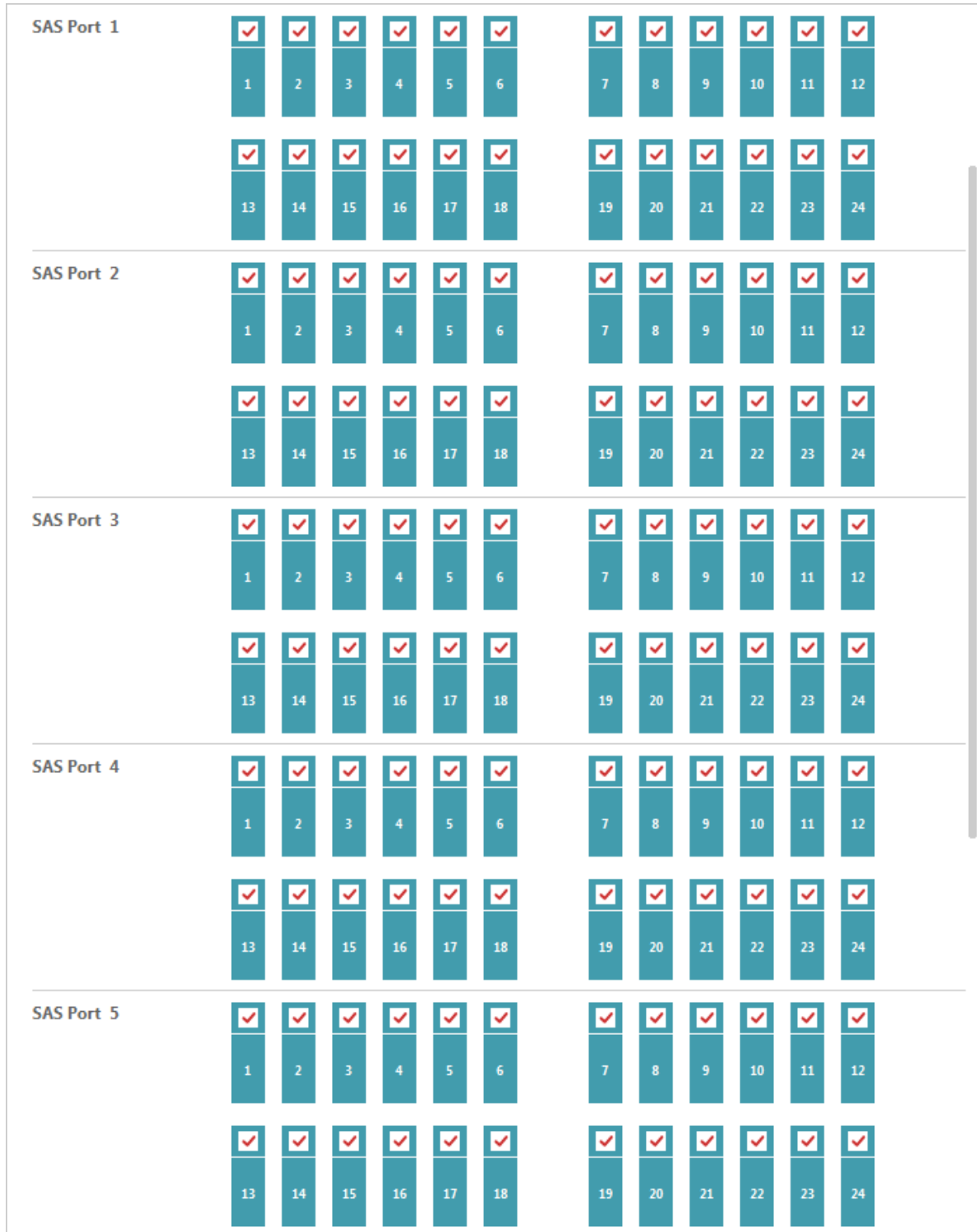

Figure 3-5 All SAS Ports Access All Drives Configuration

## SAS Ports and Disk Drives Divided into Two Groups

You can configure the zoning setting for each port according to requirement. Here is an example of two zones of SAS ports and disk drives. SAS port 1 and 2 can access to the disk drive slot 1 ~ 12, and SAS port 3, 4, 5 can access to the disk drive slot 13 ~ 24.

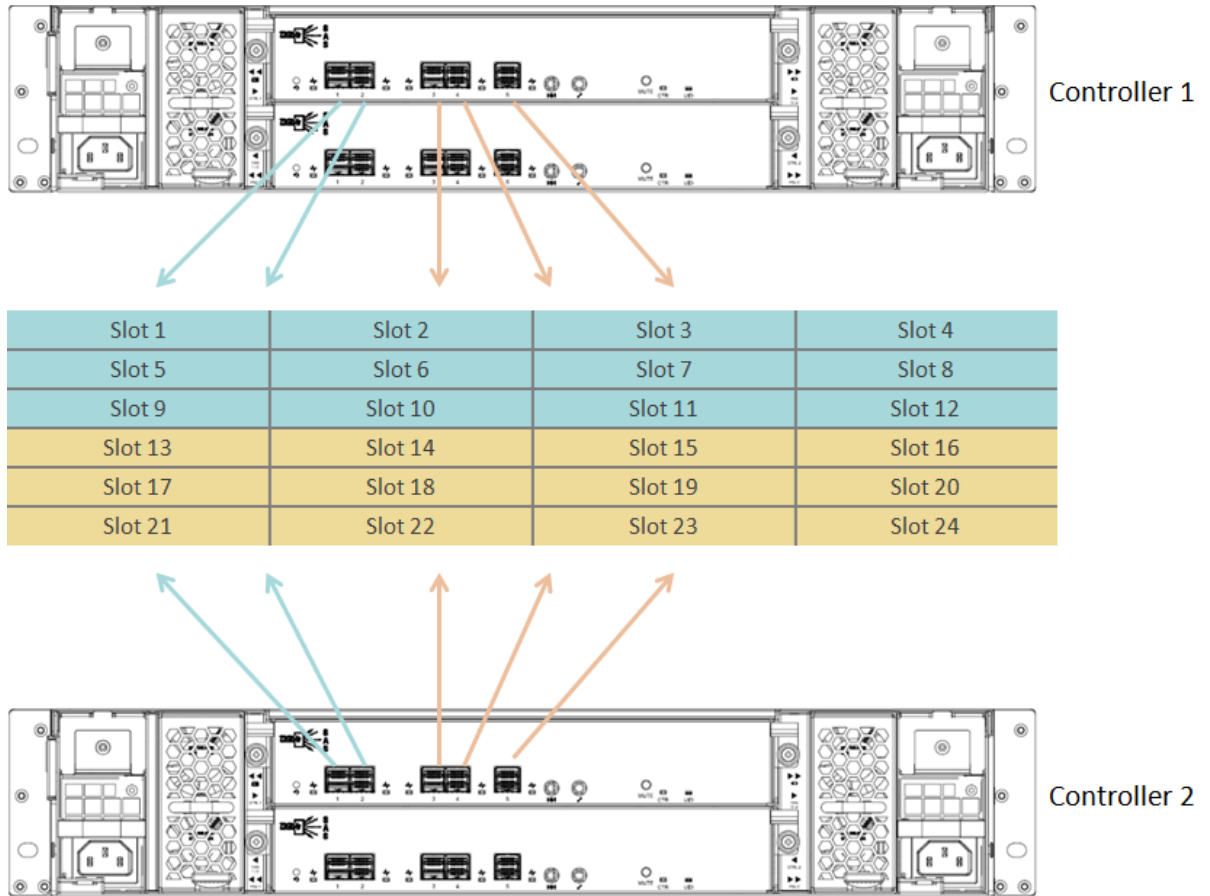

Figure 3-6 SAS Ports and Disk Drives Divided into Two Groups Diagram

The SAS zoning configuration is on the following.



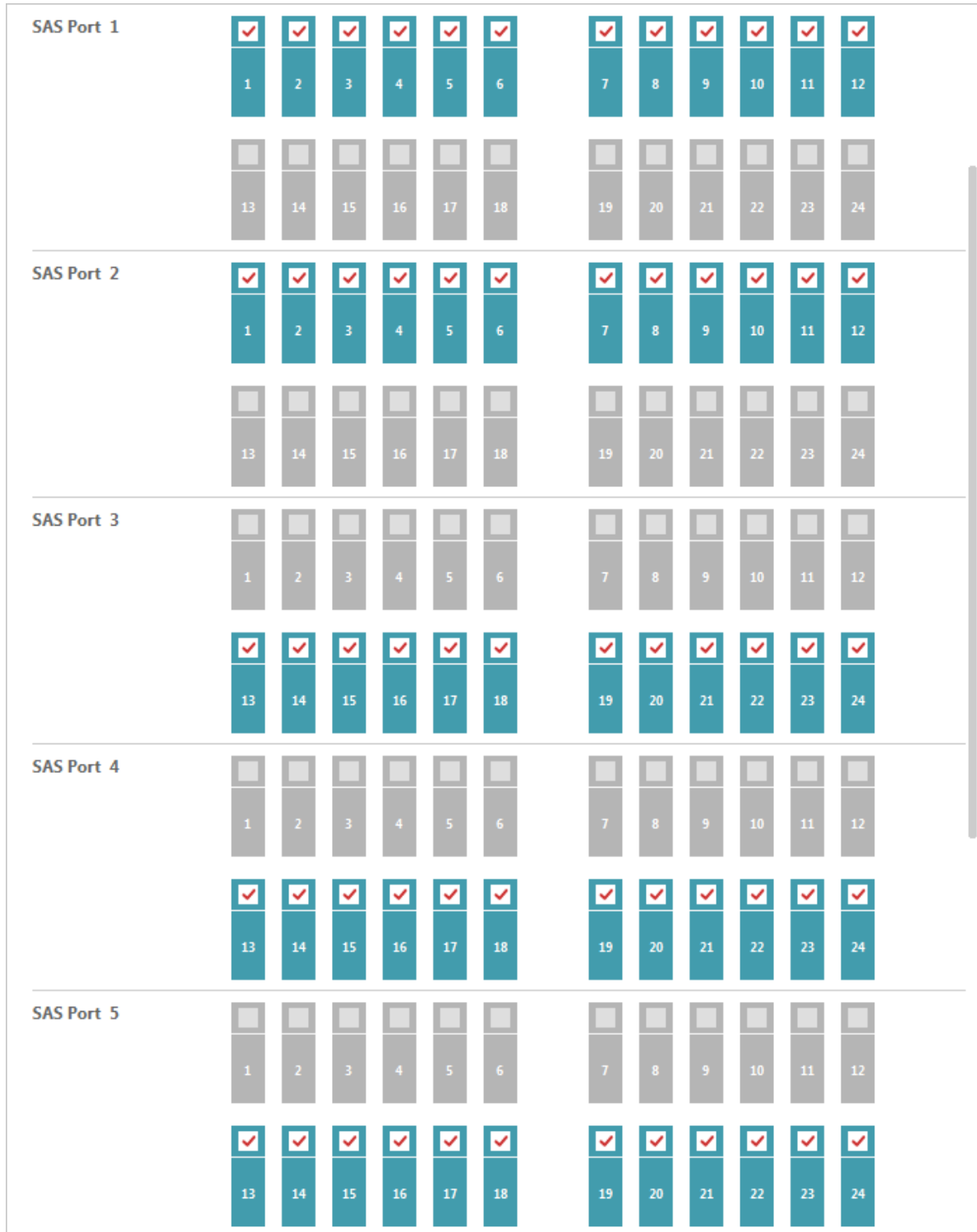

Figure 3-7 SAS Ports and Disk Drives Divided into Two Groups Configuration

## SAS Ports and Disk Drives Divided into Five Groups

Here is an example of five zones of SAS ports and disk drives. SAS port 1 can access to the disk drive slot 1 ~ 5, SAS port 2 can access to the disk drive slot 6 ~ 10, SAS port 3 can access to the disk drive slot 11 ~ 15, SAS port 4 can access to the disk drive slot 16 ~ 20, and SAS port 5 can access to the disk drive slot 21 ~ 24.

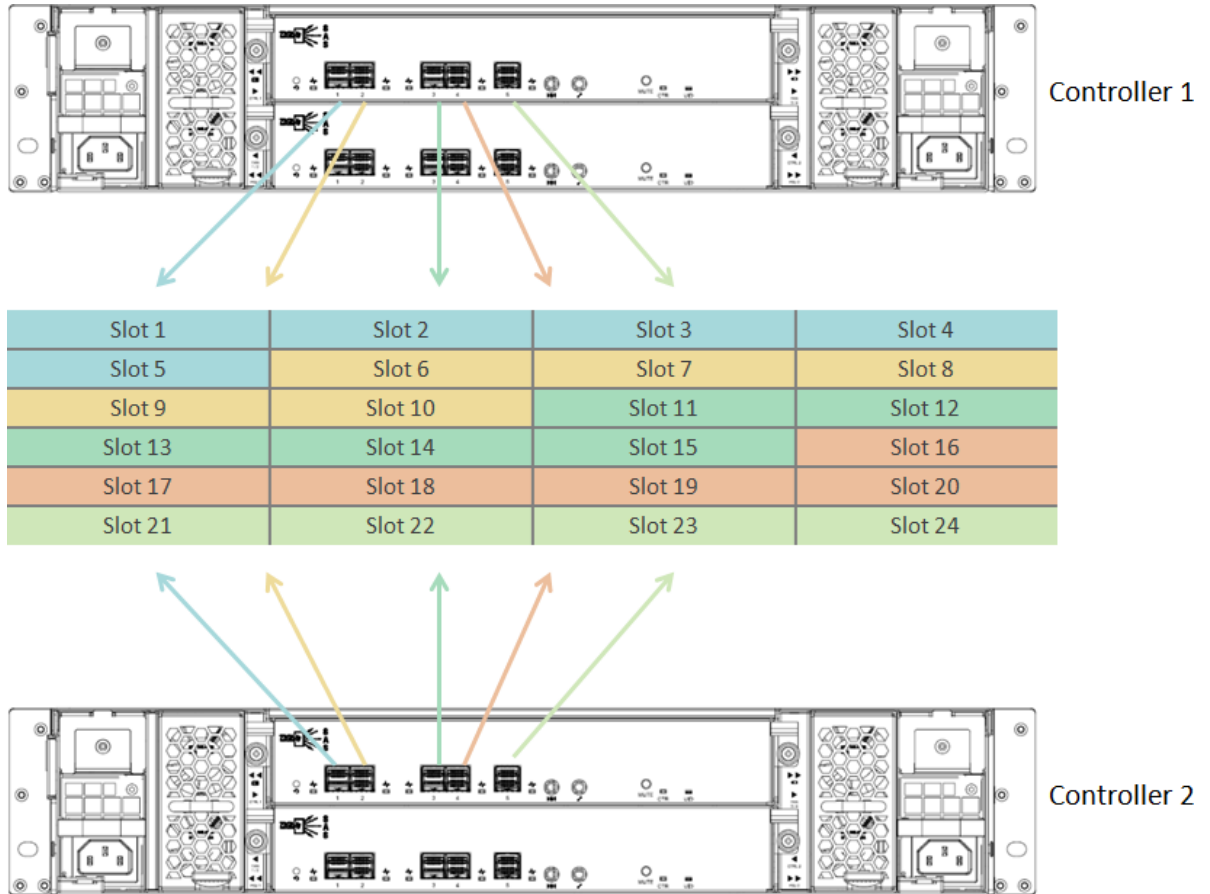

Figure 3-8 SAS Ports and Disk Drives Divided into Five Groups Diagram

The SAS zoning configuration is on the following.

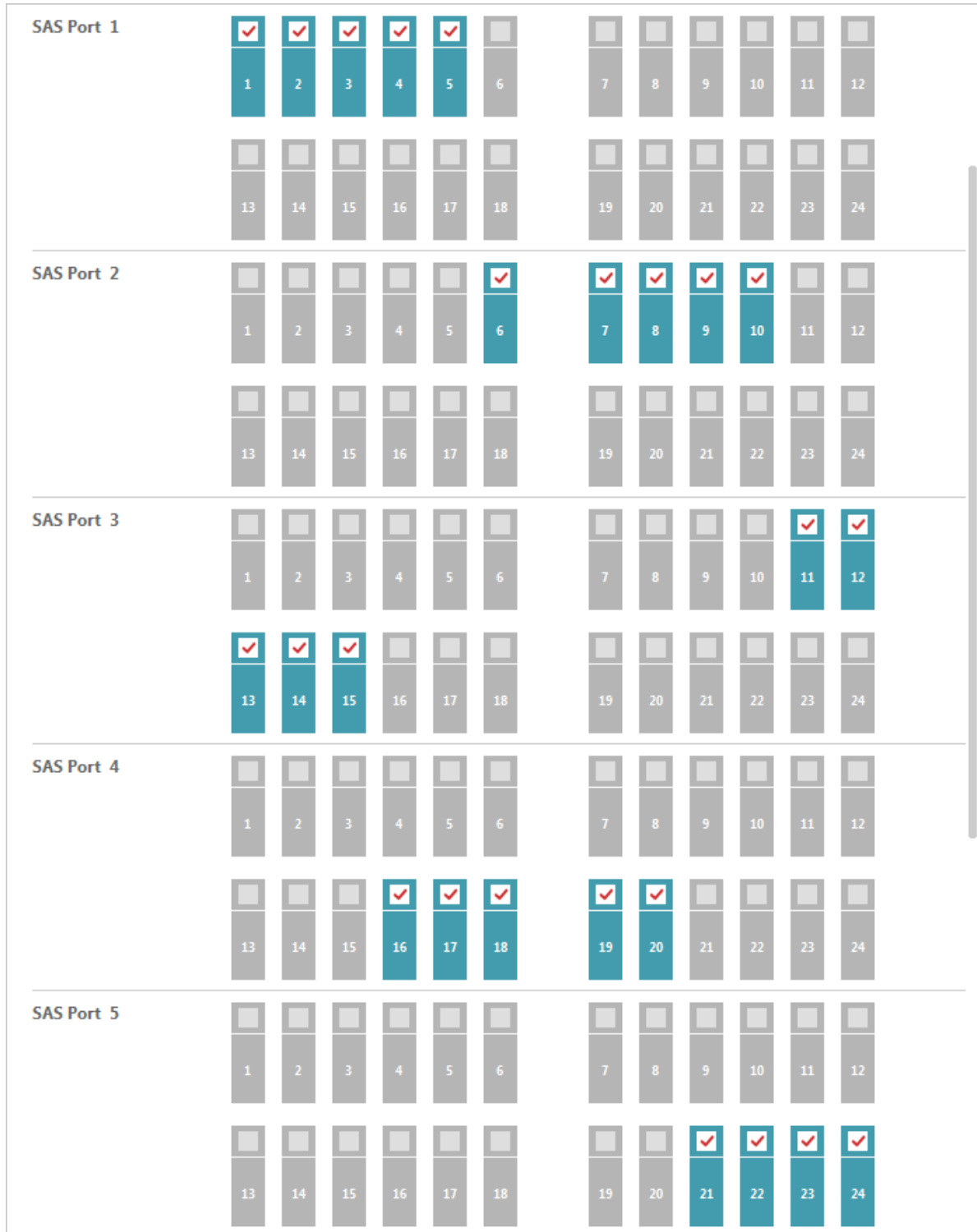

Figure 3-9 SAS Ports and Disk Drives Divided into Five Groups Configuration

Make sure to click the **Apply** button to apply the SAS zoning settings and click the **Restart** button to take effect.

## 3.2.1. SAS Zoning Cabling

The SAS zoning configuration can only apply to the first layer of XCubeDAS system when cascading multiple XCubeDAS systems. Usage examples are illustrated in the following.

### Two Servers to One XCubeDAS / Two SAS Zones

In this case, XCubeDAS is configured to two SAS zones for access right control. There is no storage expansion follows XCubeDAS system.

SAS zoning plan is listed as below:

- Zone 1: Port 1 and Port 2. Port 1 is for host connectivity, Port 2 is disconnected.
- Zone 2: Port 3 and Port 4. Port 3 is for host connectivity, Port 4 is disconnected.

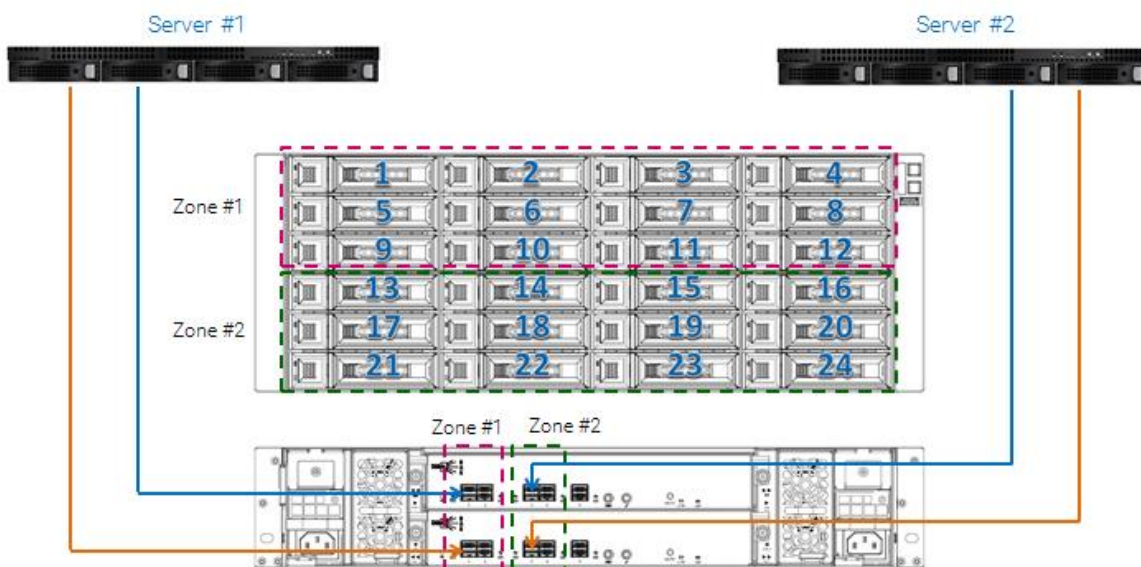

Figure 3-10 Two Servers to One XCubeDAS / Two Zones

### Two Servers to Three XCubeDAS / Two SAS Zones

In this case, XCubeDAS is configured to two SAS zones for access right control. There are two XCubeDAS systems deployment for storage expansion follows one XCubeDAS system. Only the XCubeDAS system on top layer can set SAS zones, the XCubeDAS systems cascaded to it is only for storage expansion.

SAS zoning plan is listed as below:

- Zone 1: Port 1 and Port 2. Port 1 is for host connectivity, Port 2 is for expansion.
- Zone 2: Port 3 and Port 4. Port 3 is for host connectivity, Port 4 is for expansion.

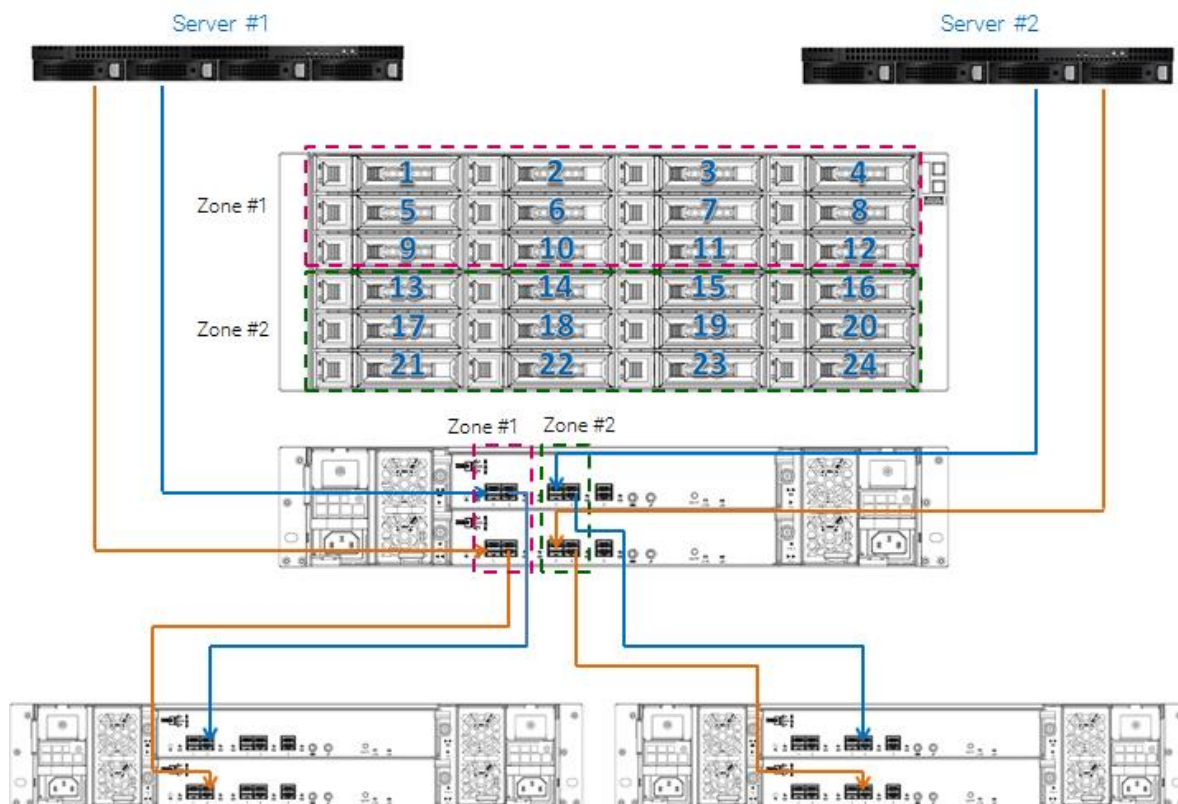

Figure 3-11 Two Servers to Three XCubeDAS / Two SAS Zones



**TIP:**

Only the XCubeDAS system on top layer can set SAS zones, the XCubeDAS systems cascaded to it is only for storage expansion.

### 3.3. Device Slot

The **Device Slot** tab provides to show the disk drive information and indicator control for the disk drives installed in slots.

- **Disk Drive information:** Show each disk drive’s vendor, model name and serial number. Besides, if the disk drive is healthy, the device slot status will be blank; if the disk drive has any problem, the device slot status will show fault indicator **Fault** under the disk device slot.
- **ID LED:** Users can turn on the disk drive ID LED for maintenance, click the ID LED to turn on the ID LED and click again to turn it off.

| Device Slot    |   |         |             |                      |
|----------------|---|---------|-------------|----------------------|
| Device Slot 1  | ID LED: <input checked="" type="checkbox"/> | TOSHIBA | AL14SEB120N | 45R0A03HFV2B         |
| Device Slot 2  | ID LED: <input checked="" type="checkbox"/> | TOSHIBA | AL14SEB120N | 45R0A03GFV2B         |
| Device Slot 3  | ID LED: <input type="checkbox"/>            | TOSHIBA | AL14SEB120N | 45R0A01MFV2B         |
| Device Slot 4  | ID LED: <input type="checkbox"/>            | TOSHIBA | AL14SEB120N | 45R0A03JFV2B         |
| Device Slot 5  | ID LED: <input type="checkbox"/>            | SEAGATE | ST500NM0001 | Z1M0JD7H0000C2101TJW |
| Device Slot 6  | ID LED: <input type="checkbox"/>            | SEAGATE | ST500NM0001 | Z1M0Q1GC0000C24816DC |
| Device Slot 7  | ID LED: <input type="checkbox"/>            | SEAGATE | ST500NM0001 | Z1M0J8LS0000C2438VSR |
| Device Slot 8  | ID LED: <input type="checkbox"/>            | SEAGATE | ST500NM0001 | Z1M0JF3X0000C24328M1 |
| Device Slot 9  | ID LED: <input type="checkbox"/>            | SEAGATE | ST500NM0001 | Z1M0H0S900009242B6PU |
| Device Slot 10 | ID LED: <input type="checkbox"/>            | SEAGATE | ST500NM0001 | Z1M0PB8B0000C2487U7A |
| Device Slot 11 | ID LED: <input type="checkbox"/>            | SEAGATE | ST500NM0001 | Z1M0JDX0000C243B1H4  |
| Device Slot 12 | ID LED: <input type="checkbox"/>            | SEAGATE | ST500NM0001 | Z1M0PX4T0000C2485UY7 |

Figure 3-12 Device Slots Status



**INFORMATION:**

For the front and rear view about the disk drive ID LED, please refer to chapter 2, System Components Overview in the [XCubeDAS Hardware Owner's Manual](#).

### 3.4. Power Supply

The **Power Supply** tab provides to monitor the status of power supply unit and indicate error conditions. The error indicators are on the following.

- **DC Over Voltage:** If the DC voltage is over default upper limit, DC OVER VOLTAGE indicator will be on and show orange color.

- **DC Under Voltage:** if the DC voltage is over default lower limit, DC UNDER VOLTAGE indicator will be on and show **amber** color.
- **DC Over Current:** if the DC current is over default limit, DC OVER CURRENT indicator will be on and show **amber** color.
- **Overtemp Fail:** if the temperature is over default limit, OVERTEMP FAIL indicator will be on and show dark **red** color.
- **Temp Warn:** if the temperature is close to default limit, TEMP WARN indicator will on and show **amber** color.
- **AC Fail:** if the input AC is abnormal (too high/low voltage), AC FAIL indicator will be on and show dark **red** color.

| Power Supply   |                 |                  |                 |               |           |         |
|----------------|-----------------|------------------|-----------------|---------------|-----------|---------|
| Power Supply 1 | DC Over Voltage | DC Under Voltage | DC Over Current | Overtemp Fail | Temp Warn | AC Fail |
| Power Supply 2 | DC Over Voltage | DC Under Voltage | DC Over Current | Overtemp Fail | Temp Warn | AC Fail |

Figure 3-13 Power Supply Status Indicators

### 3.5. Cooling Device

The **Cooling Device** tab provides to monitor the status of the cooling devices. The cooling device indicators will show the following information.

- **Cooling Device Number:** There are four cooling devices numbering 1 to 4.
- **Cooling Device Fan Speed and RPM** (Revolutions Per Minute): The statistic chart shows the history of RPM.
- **Cooling Device Status:** If the cooling device is normal, the indicator will show blank; if the cooling device is abnormal, the indicator will show **Failed**.



**INFORMATION:**

Cooling device RPM statistic charts will be updated by every minute.

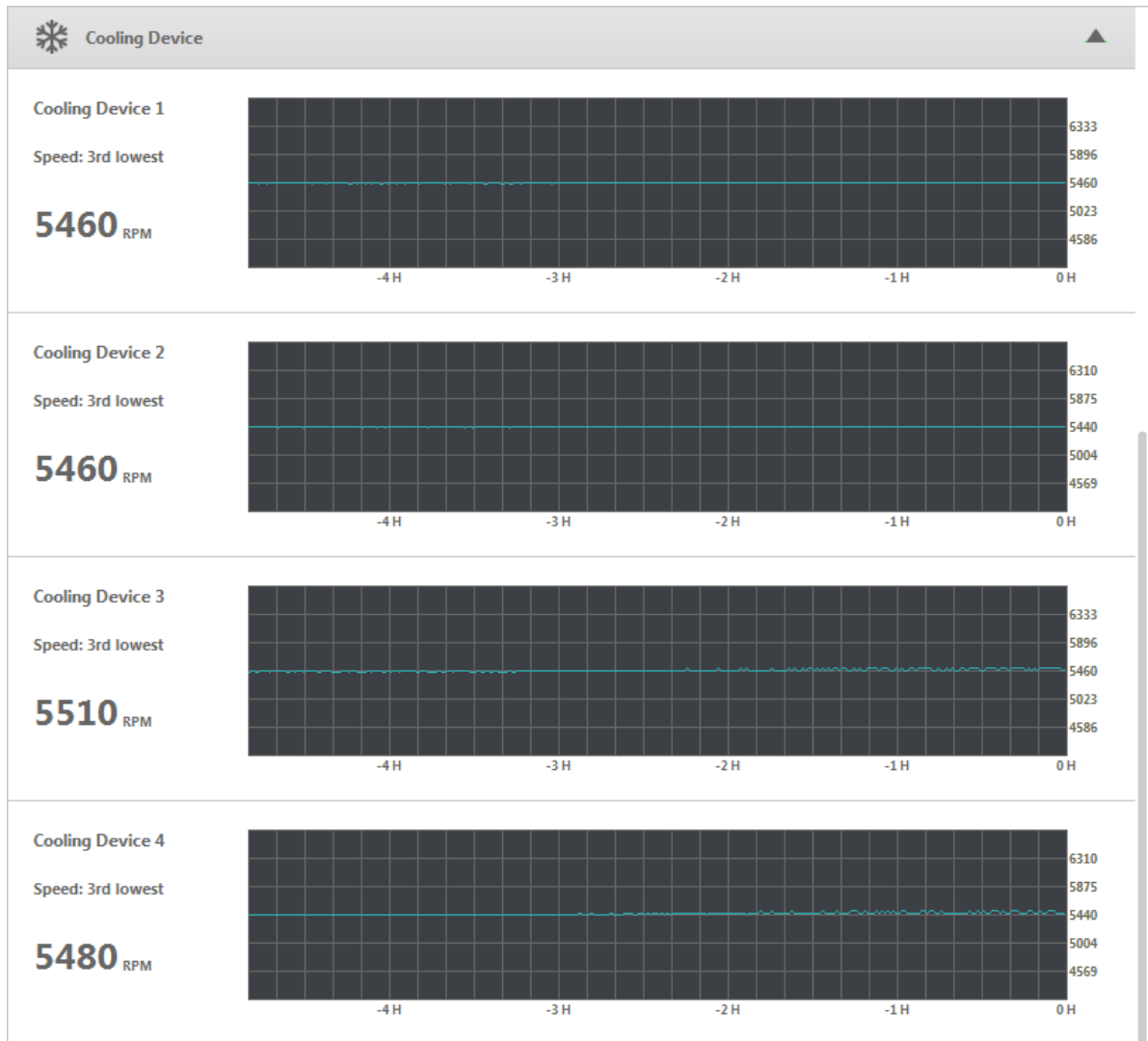

Figure 3-14 Cooling Device Status Indicators

## 3.6. Temperature Sensor

The **Temperature Sensor** tab provides to monitor the status of the temperature sensors. There are some thermal sensors in the system. Thermal sensor indicators will show the following information.

- **Temperature Sensor Name:** It indicates the location of the thermal sensor.
- **Current Temperature:** Degree by Celsius.
- **Temperature Status:** If the temperature detected by the thermal sensor is normal, the indicator will show blank; if the temperature is out of range, the indicator will show **Failed**.



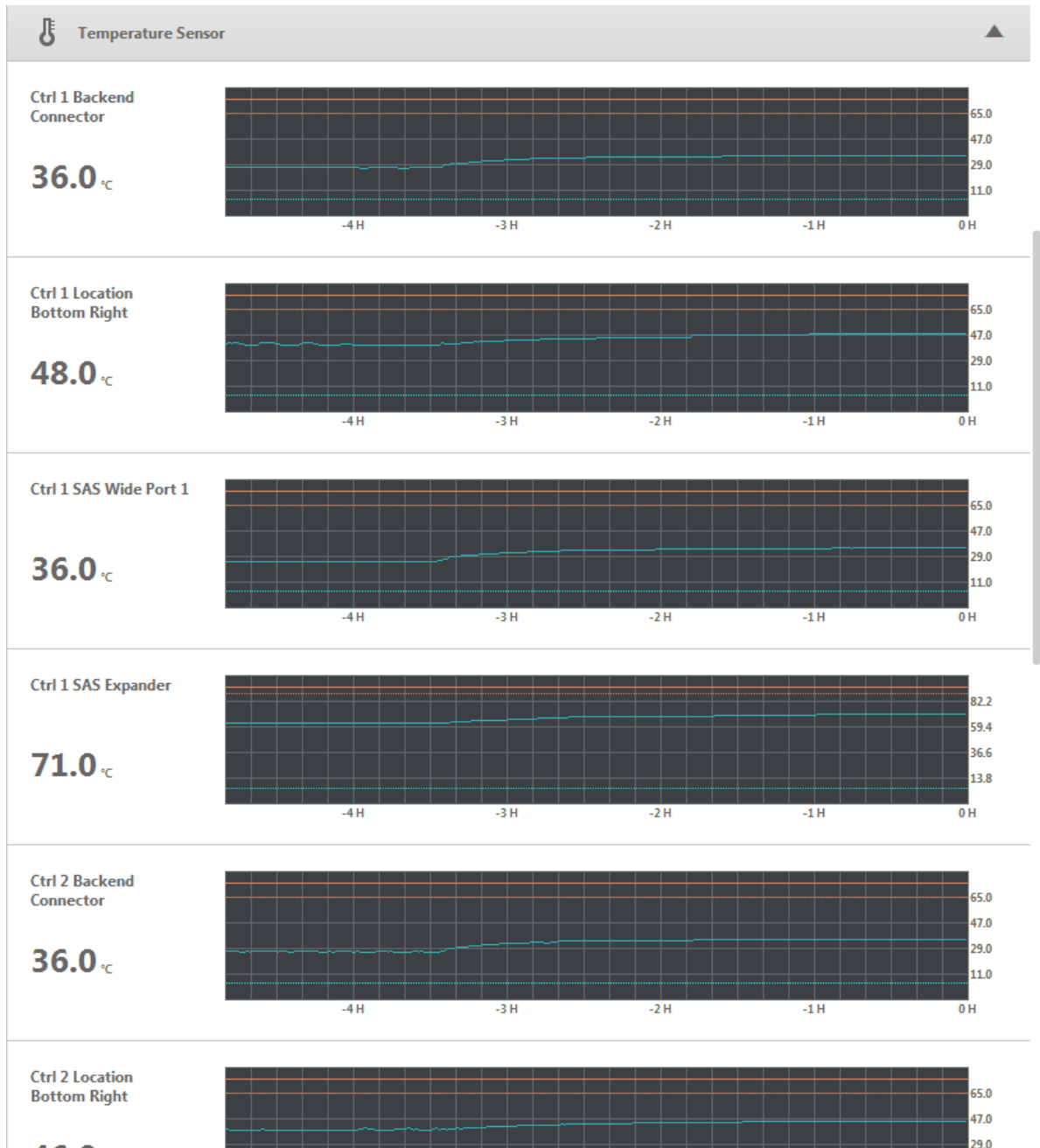

Figure 3-15 Temperature Sensor Status Indicators



**INFORMATION:**

Temperature statistic charts will be updated by every minute.

## 3.7. Voltage Sensor

The **Voltage Sensor** tab provides to monitor the status of the voltage sensors. There are many voltage sensors in the system. Voltage sensor indicators will show the following information.

- **Voltage Sensor:** It indicates the voltage sensor.
- **Current Voltage:** Number by volt.
- **Voltage Status:** If the voltage detected by the voltage sensor is normal, the indicator will show blank; if the voltage is out of range, the indicator will show **Failed**.



**INFORMATION:**

Voltage statistic charts will be updated by every minute.

---

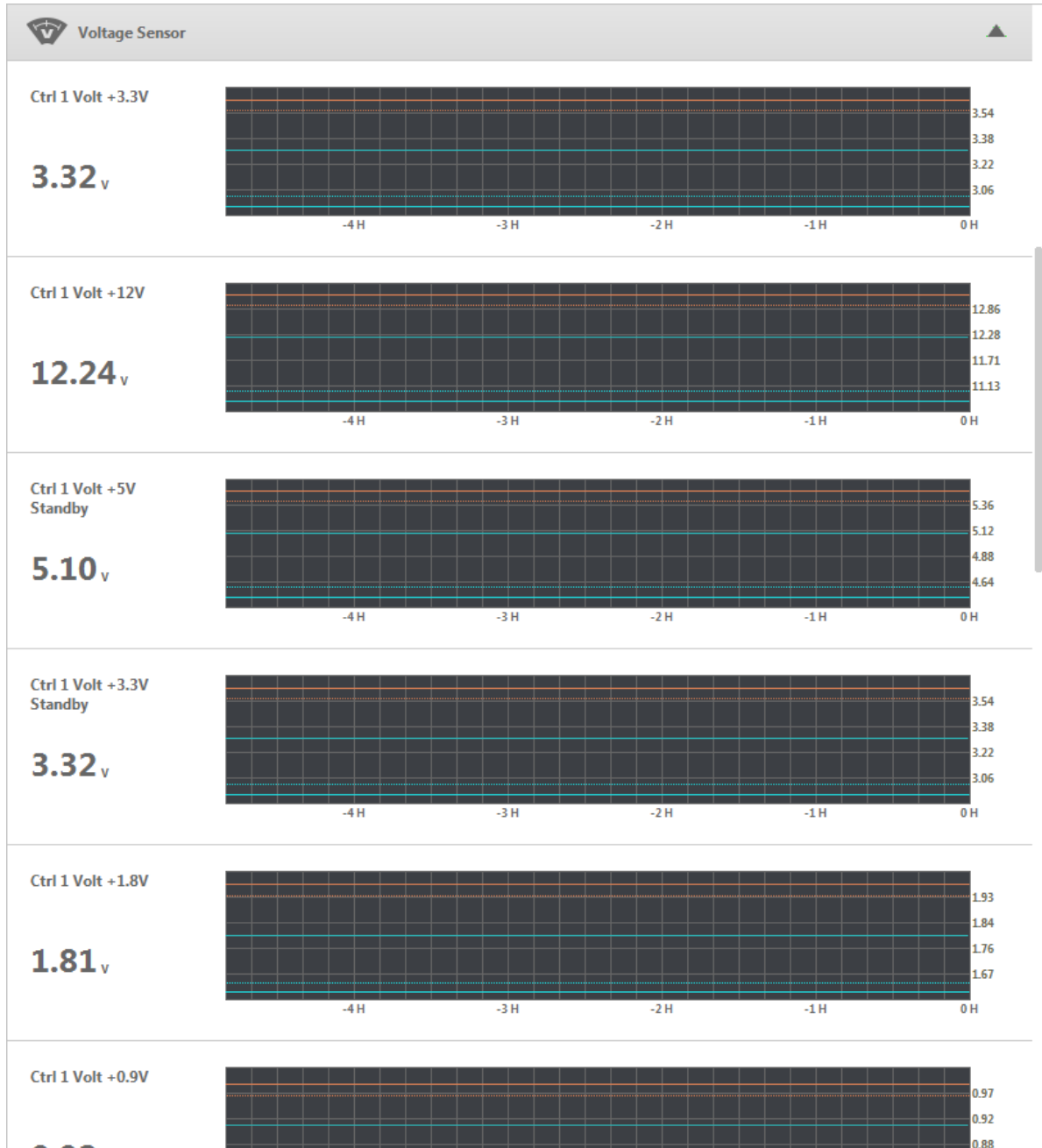

Figure 3-16 Voltage Sensor Status Indicators

### 3.8. SAS Expander

The **SAS Expander** tab provides the SAS expander information including the SAS addresses.

| SAS Expander |                               |
|--------------|-------------------------------|
| 1            | SAS Address: 5001378008001DFF |
| 2            | SAS Address: 5001378008001CFF |

Figure 3-17 SAS Expander Information

## 3.9. SAS Port

The **SAS Port** tab provides to monitor the status of the SAS ports. There are five SAS ports on each controller. The connectivity status and speed for each SAS port will be shown.

| SAS Port            |                 |                            |
|---------------------|-----------------|----------------------------|
| Controller 1 Port 1 |                 |                            |
| Controller 1 Port 2 | Connected (12G) | From port 500605B00929A320 |
| Controller 1 Port 3 |                 |                            |
| Controller 1 Port 4 |                 |                            |
| Controller 1 Port 5 |                 |                            |
| Controller 2 Port 1 |                 |                            |
| Controller 2 Port 2 | Connected (12G) | From port 500605B00929A321 |
| Controller 2 Port 3 |                 |                            |
| Controller 2 Port 4 |                 |                            |
| Controller 2 Port 5 |                 |                            |

Figure 3-18 SAS Port Connectivity Status

## 4. Support and Other Resources

---

### 4.1. Getting Technical Support

After installing your device, locate the serial number on the sticker located on the side of the chassis and use it to register your product at <https://partner.qsan.com/> (End-User Registration). We recommend registering your product in QSAN partner website for firmware updates, document download, and latest news in eDM. To contact QSAN Support, please use the following information.

- Via the Web: <https://qsan.com/support>
- Via Telephone: +886-2-7720-2118 extension 136  
(Service hours: 09:30 - 18:00, Monday - Friday, UTC+8)
- Via Skype Chat, Skype ID: qsan.support  
(Service hours: 09:30 - 02:00, Monday - Friday, UTC+8, Summer time: 09:30 - 01:00)
- Via Email: [support@qsan.com](mailto:support@qsan.com)

#### Information to collect

- Product name, model or version, and serial number
- Operating system name and version
- Firmware version
- Error messages or capture screenshots
- Product-specific reports and logs
- Add-on products or components installed
- Third-party products or components installed

#### Information for Technical Support

The following system information is necessary for technical support, please refer to following for what and where to get the information of your XCubeDAS series model.

### 4.2. Accessing Product Updates

To download product updates, please visit QSAN website:

<https://qsan.com/download>

## 4.3. Documentation Feedback

QSAN is committed to providing documentation that meets and exceeds your expectations. To help us improve the documentation, email any errors, suggestions, or comments to [docsfeedback@qsan.com](mailto:docsfeedback@qsan.com).

When submitting your feedback, include the document title, part number, revision, and publication date located on the front cover of the document.

## Appendix

---

### End-User License Agreement (EULA)

Please read this document carefully before you use our product or open the package containing our product.

YOU AGREE TO ACCEPT TERMS OF THIS EULA BY USING OUR PRODUCT, OPENING THE PACKAGE CONTAINING OUR PRODUCT OR INSTALLING THE SOFTWARE INTO OUR PRODUCT. IF YOU DO NOT AGREE TO TERMS OF THIS EULA, YOU MAY RETURN THE PRODUCT TO THE RESELLER WHERE YOU PURCHASED IT FOR A REFUND IN ACCORDANCE WITH THE RESELLER'S APPLICABLE RETURN POLICY.

#### **General**

QSAN Technology, Inc. ("QSAN") is willing to grant you ("User") a license of software, firmware and/or other product sold, manufactured or offered by QSAN ("the Product") pursuant to this EULA.

#### **License Grant**

QSAN grants to User a personal, non-exclusive, non-transferable, non-distributable, non-assignable, non-sub-licensable license to install and use the Product pursuant to the terms of this EULA. Any right beyond this EULA will not be granted.

#### **Intellectual Property Right**

Intellectual property rights relative to the Product are the property of QSAN or its licensor(s). User will not acquire any intellectual property by this EULA.

#### **License Limitations**

User may not, and may not authorize or permit any third party to: (a) use the Product for any purpose other than in connection with the Product or in a manner inconsistent with the design or documentations of the Product; (b) license, distribute, lease, rent, lend, transfer, assign or otherwise dispose of the Product or use the Product in any commercial hosted or service bureau environment; (c) reverse engineer, decompile, disassemble or attempt to discover the source code for or any trade secrets related to the Product, except and only to

the extent that such activity is expressly permitted by applicable law notwithstanding this limitation; (d) adapt, modify, alter, translate or create any derivative works of the Licensed Software; (e) remove, alter or obscure any copyright notice or other proprietary rights notice on the Product; or (f) circumvent or attempt to circumvent any methods employed by QSAN to control access to the components, features or functions of the Product.

## **Disclaimer**

QSAN DISCLAIMS ALL WARRANTIES OF PRODUCT, INCLUDING BUT NOT LIMITED TO ANY MERCHANTABILITY, FITNESS FOR A PARTICULAR PURPOSE, WORKMANLIKE EFFORT, TITLE, AND NON-INFRINGEMENT. ALL PRODUCTS ARE PROVIDED "AS IS" WITHOUT WARRANTY OF ANY KIND. QSAN MAKES NO WARRANTY THAT THE PRODUCT WILL BE FREE OF BUGS, ERRORS, VIRUSES OR OTHER DEFECTS.

IN NO EVENT WILL QSAN BE LIABLE FOR THE COST OF COVER OR FOR ANY DIRECT, INDIRECT, SPECIAL, PUNITIVE, INCIDENTAL, CONSEQUENTIAL OR SIMILAR DAMAGES OR LIABILITIES WHATSOEVER (INCLUDING, BUT NOT LIMITED TO LOSS OF DATA, INFORMATION, REVENUE, PROFIT OR BUSINESS) ARISING OUT OF OR RELATING TO THE USE OR INABILITY TO USE THE PRODUCT OR OTHERWISE UNDER OR IN CONNECTION WITH THIS EULA OR THE PRODUCT, WHETHER BASED ON CONTRACT, TORT (INCLUDING NEGLIGENCE), STRICT LIABILITY OR OTHER THEORY EVEN IF QSAN HAS BEEN ADVISED OF THE POSSIBILITY OF SUCH DAMAGES.

## **Limitation of Liability**

IN ANY CASE, QSAN'S LIABILITY ARISING OUT OF OR IN CONNECTION WITH THIS EULA OR THE PRODUCT WILL BE LIMITED TO THE TOTAL AMOUNT ACTUALLY AND ORIGINALLY PAID BY CUSTOMER FOR THE PRODUCT. The foregoing Disclaimer and Limitation of Liability will apply to the maximum extent permitted by applicable law. Some jurisdictions do not allow the exclusion or limitation of incidental or consequential damages, so the exclusions and limitations set forth above may not apply.

## **Termination**

If User breaches any of its obligations under this EULA, QSAN may terminate this EULA and take remedies available to QSAN immediately.

## **Miscellaneous**

- QSAN reserves the right to modify this EULA.
- QSAN reserves the right to renew the software or firmware anytime.



- QSAN may assign its rights and obligations under this EULA to any third party without condition.
- This EULA will be binding upon and will inure to User's successors and permitted assigns.
- This EULA shall be governed by and constructed according to the laws of R.O.C. Any disputes arising from or in connection with this EULA, User agree to submit to the jurisdiction of Taiwan Shilin district court as first instance trial.